

LINK

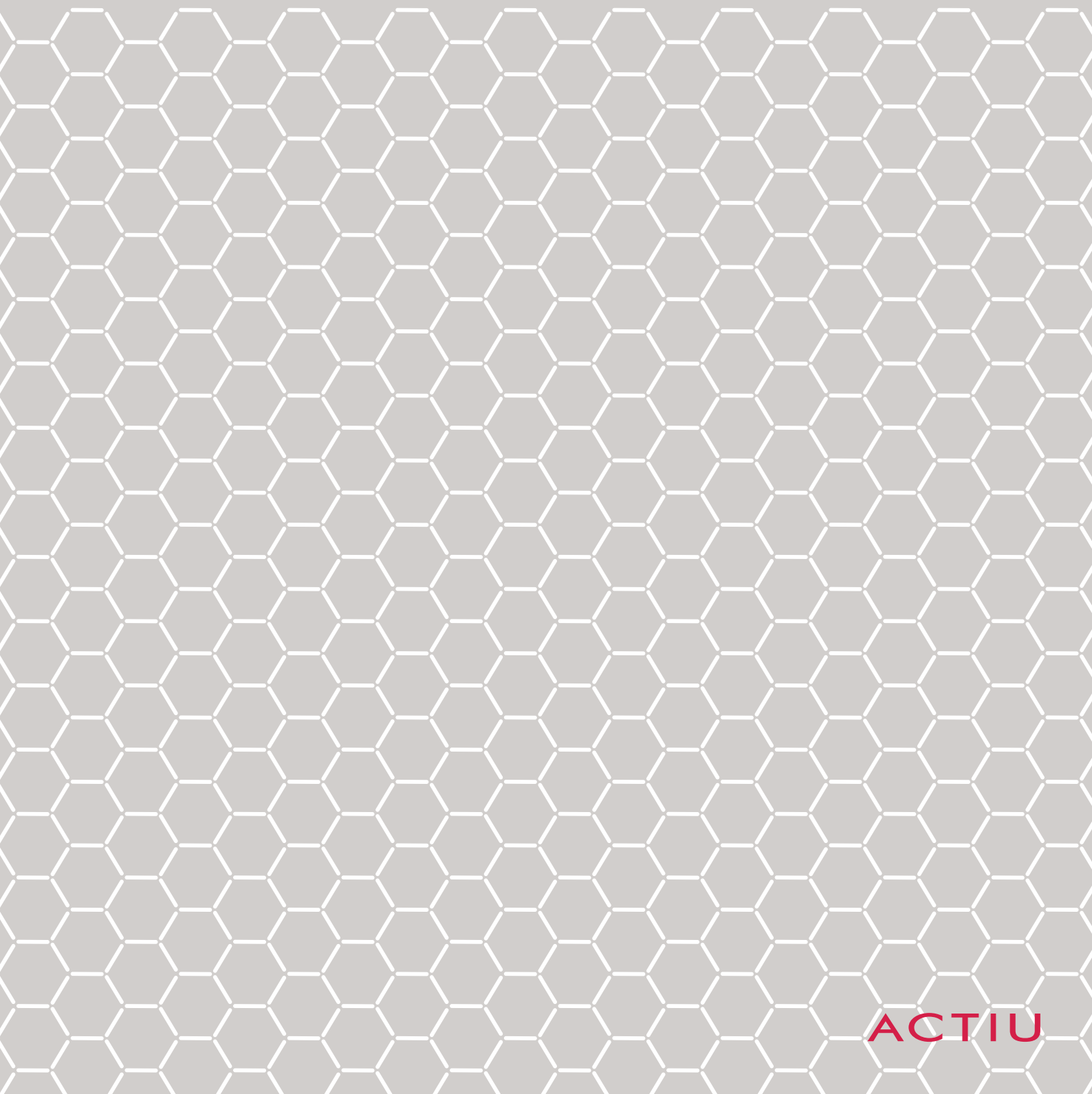

ACTIU

# LINK

— DOCK SYSTEM —

  
[www.actiu.com/link](http://www.actiu.com/link)



WE ARE ALWAYS ON THE MOVE, AND YOU?



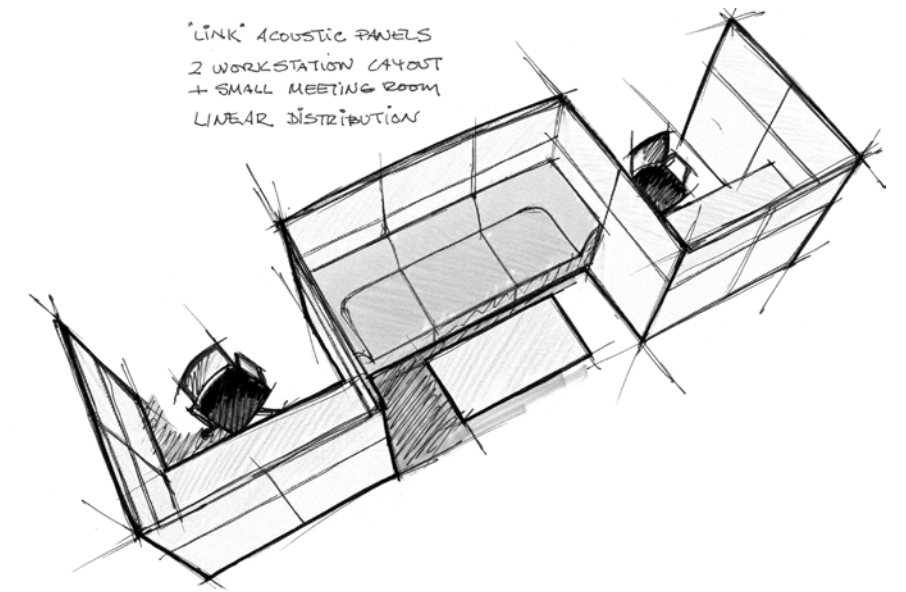
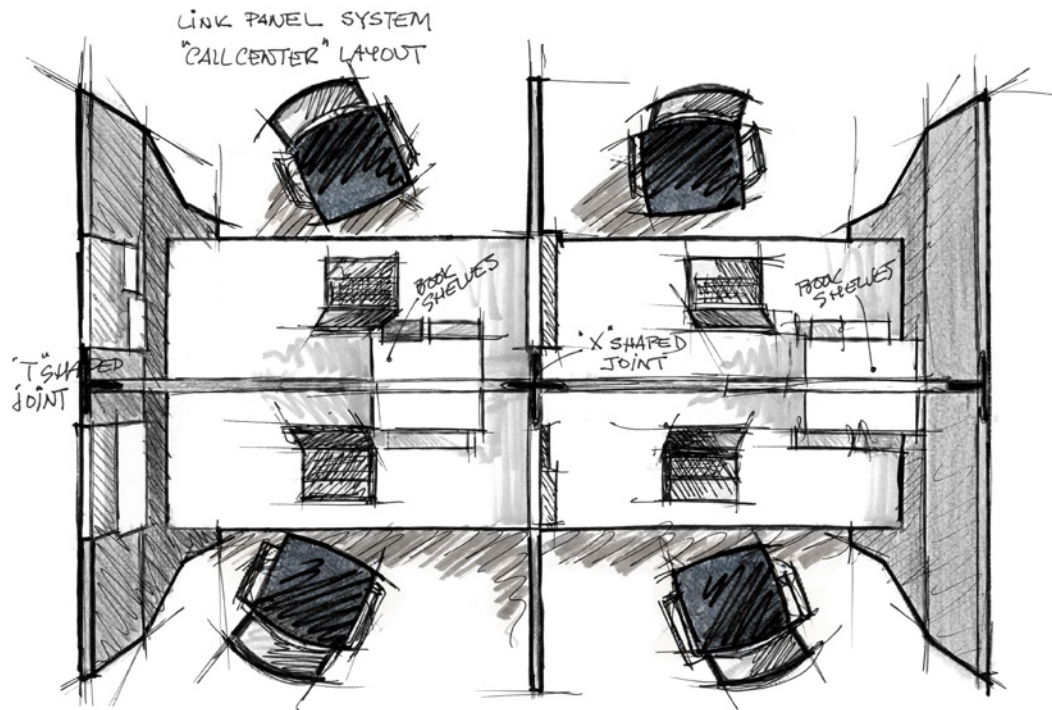

Les nouvelles tendances dans le design des bureaux est la flexibilité de concevoir des espaces privés avec des espaces ouverts et collaboratifs pour que la créativité et la communication circulent de manière continue et naturelle. Cette évolution de concevoir les nouveaux espaces de travail oblige à adapter le mobilier pour être un lieu flexible et polyvalent. LINK est un système modulaire et de configuration des espaces de différentes hauteurs pour permettre de créer un infini de possibilités pour adapter les espaces de travail à chaque besoin.

Die neuen Trends in der Bürogestaltung setzen auf eine Kombination von abgeschirmten und offenen, kooperativen Bereichen, wo Kommunikation und Kreativität sich ganz natürlich entwickeln können. Die Entwicklung moderner Arbeitsbereiche geht mit der Notwendigkeit einher, das Mobiliar anzupassen um es flexibel und polyvalent zu nutzen. Mit dem Modulsystem LINK lassen sich Arbeitsbereiche in verschiedenen Höhen schaffen und gestalten. Seine Flexibilität eröffnet eine Vielzahl von Möglichkeiten für Arbeitsbereiche mit verschiedensten Funktionen.

## LINK BY ITEMdesignworks

The new trends in office design suggest combining privacy with open and collaborative offices, where creativity and communication flow in a natural way. This evolution in the way of understanding work environments lead us to the need to adapt the furniture so that it is flexible and versatile. LINK is a modular system which creates and configures spaces of different heights that enables endless design possibilities to adapt work spaces to every need.

Las nuevas tendencias en el diseño de oficinas sugieren combinar espacios de privacidad con otros abiertos y colaborativos, donde la creatividad y la comunicación fluyen de manera natural. Esta evolución en las formas de concebir los entornos de trabajo conducen a la necesidad de adaptar el mobiliario para que resulte flexible y polivalente.

LINK es un sistema modular de creación y configuración de espacios de distintas alturas que permiten diseñar un sinfín de posibilidades para adaptar los espacios de trabajo a cada necesidad.

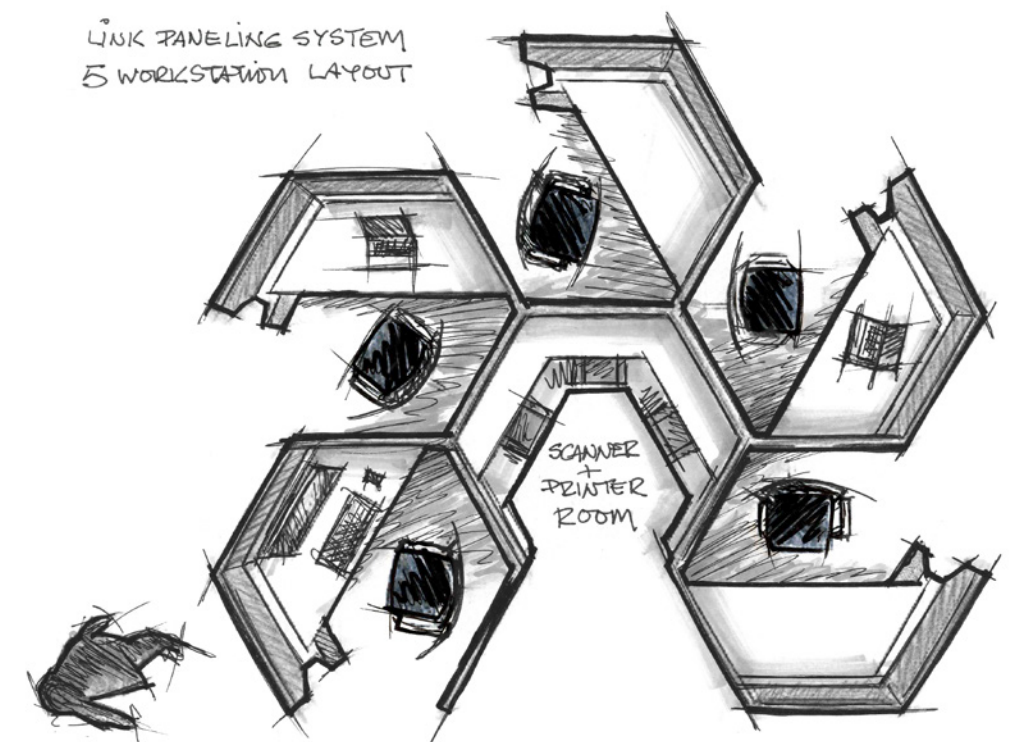







For this type of program to really be functional and effective in a workspace, it is essential to have total connectivity, both with the electricity and all the different networks. For this, LINK has a complete electrification system which enables immediate connection for all types of devices.

Para que este tipo de programas realmente sean funcionales y efectivos en un espacio laboral, es preciso que cuenten con una conectividad total, tanto a la electricidad como a las distintas redes. Por ello LINK, cuenta con un completo sistema de electrificación que permite una conexión inmediata para todo tipo de dispositivos.

Pour que ce type de programme fonctionne véritablement, il est nécessaire d'assurer une connectivité totale, en électricité et des différents réseaux. Pour cela LINK dispose d'un système complet d'électrification permettant une connexion immédiate à tous les dispositifs.

Um mit solch einem Mobiliarsystem wirklich funktional und effektiv Arbeitsbereiche gestalten zu können, muss eine uneingeschränkte Konnektivität sowohl bei der Stromversorgung als auch den verschiedenen Netzwerken sichergestellt sein. Dazu ist LINK mit einer kompletten Verkabelung ausgestattet, an die sich umgehend alle möglichen Geräte anschließen lassen.



Height adjustment / Regulacion de altura

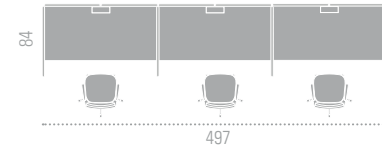



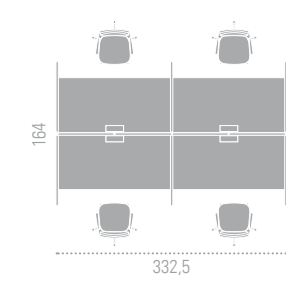





## LINK. MICROARCHITECTURES FOR CURRENT WORKSPACES

It is a light, different program with personality. It works to complement and act as a transition between more individual areas of the office and other more open and collective places. To do this and by means of accessories that make it more operative and dynamic, LINK can combine modular sofas, operative desks and other accessories which expand the possibilities within the office, with the aim to stimulate efficiency of people through comfort and change.

Es un programa ligero, diferente y con personalidad. Funciona como complemento y transición entre las zonas más individuales de la oficina y otros lugares abiertos y colectivos. Para ello, y por medio de accesorios que lo convierten en más operativo y dinámico, LINK se puede combinar con sofás modulares, mesas operativas y otro tipo de complementos que amplían las posibilidades dentro de la oficina, con el objetivo de estimular la eficiencia de las personas a través de la comodidad y el cambio.

C'est un programme léger, différent et avec du caractère. C'est un complément et une transition entre les zones individuelles du bureau, les autres espaces ouverts et les collectivités. Pour cela, des annexes sont disponibles pour rendre ce lieu plus opératif et dynamique. Link peut se combiner avec les fauteuils modulaires, les tables opératives et un autre type de complément pour stimuler l'efficacité de chaque personne dans une ambiance confortable et différente.

Es ist ein leichtes System, anders als andere, mit viel Persönlichkeit. Es lässt sich als Komplement und Übergang zwischen individuelleren Bürobereichen und den offenen, kollektiven Bereichen einsetzen. Dazu lässt sich LINK anhand von Accessoires kombinieren, die für zusätzlichen praktischen Nutzen und Dynamik sorgen. Mit Sofamodulen, Schreibtischen und weiteren Zusätzen wird der Nutzwert des Büros erhöht. Ziel dabei ist, über die Bequemlichkeit beim Arbeiten und den Wechsel zwischen verschiedenen Szenarien zu mehr Effizienz anzuregen.





LINK  
DOCK SYSTEM







Produced with an internal steel structure and soundproofing materials, LINK presents an auto assembly modular system from pieces of injected aluminium which enable multiple possibilities using by joining modules to create rectangular, hexagonal, radial or linear growth configurations, creating individual operative positions, video conference rooms, reading or meeting points.

Producida con una estructura interna de acero y materiales fonoabsorbentes, LINK presenta un sistema modular de automontaje a partir de piezas de inyección de aluminio que permite múltiples posibilidades mediante la unión de sus módulos, pudiendo crear configuraciones rectangulares, hexagonales, de crecimiento radial (colmena) o lineal, creando puestos operativos individuales, salas de videoconferencias, telecabinas, puntos de lectura o meeting.

Fabriqué avec une structure interne en acier et des matériaux isolant phoniques, LINK est un système modulaire d'auto-montage à partir de pièces en injection d'aluminium. Pour offrir de multiples possibilités grâce à l'union de ses modules. Vous pouvez créer des ensembles rectangulaires, hexagonaux, de croissance radiale (en ruche) ou linéaire pour des postes opératifs individuels, des salles de vidéoconférences, des cabines, des points de lecture ou de meeting.

Die innere Struktur von LINK besteht aus Stahl und es werden schalldämmende Materialien verwendet. Das Modulare System für die Montage vor Ort basiert auf Verbindungselementen aus Druckguss-Aluminium. Es bietet vielfältige Kombinationsmöglichkeiten der einzelnen Module und erlaubt rechteckige, sechseckige, Strahlenförmige oder lineare Anordnungen. Es lassen sich individuelle Arbeitsplätze einrichten, Videokonferenzräume, Telefonkabinen, Lesecken oder Besprechungsszenarien.







LINK IS A LIGHT,  
DIFFERENT PROGRAM  
WITH PERSONALITY

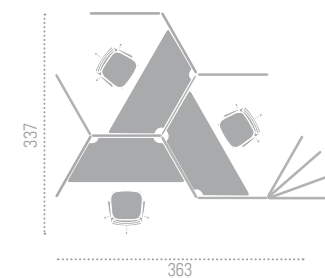



LINK: THE VERSATILE  
AND MODULAR OFFICE

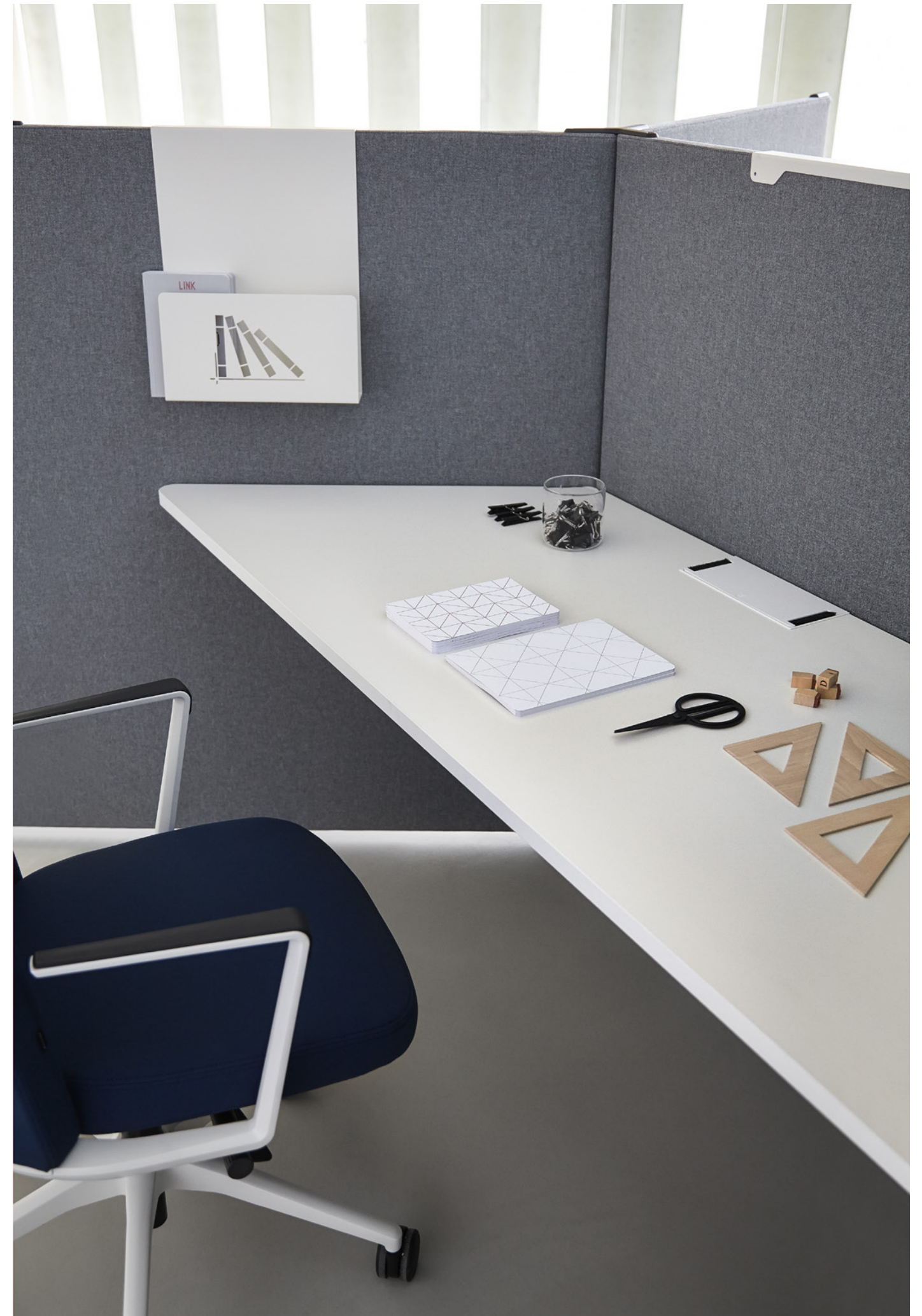





MEETING AT  
10 AM NEXT  
MONDAY





The possibilities are endless and adjustable at any minute. A completely personalised option, which creates microarchitectures for designers and architects and thus exploit all the possibilities of an office promoting the efficiency of the people who use it each day.

Las posibilidades son infinitas, y reajustables en todo momento. Una opción completamente personalizable, que permite crear microarquitecturas al servicio de decoradores y arquitectos, y explotar así, todas las posibilidades de una oficina estimulando la eficiencia de las personas que la utilizan cada día.

Les possibilités sont infinies et modifiables à tout moment. La possibilité de personnalisation permet de créer une microarchitecture au service des décorateurs et des architectes. Vous pouvez exploiter toutes les possibilités de cet espace de travail en stimulant chaque jour l'efficacité des personnes qui l'utilisent.

Nahezu unbegrenzte Möglichkeiten - und eine Umgestaltung ist jederzeit möglich. Eine rundum individuell gestaltbare Lösung also, mit der Innendesigner und Architekten wahre Mini-Architekturen realisieren können, die das ganze Potential einer gegebenen Bürofläche nutzen und die hier tätigen Menschen Tag für Tag zu effizientem Arbeiten anregen.





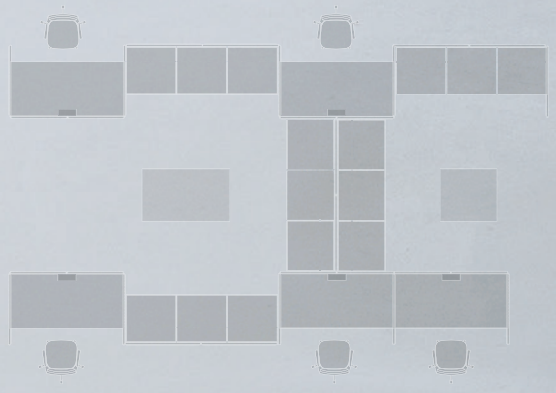

489

745







# SETTING YOUR OWN LINK

CONFIGURA TU PROPIO LINK

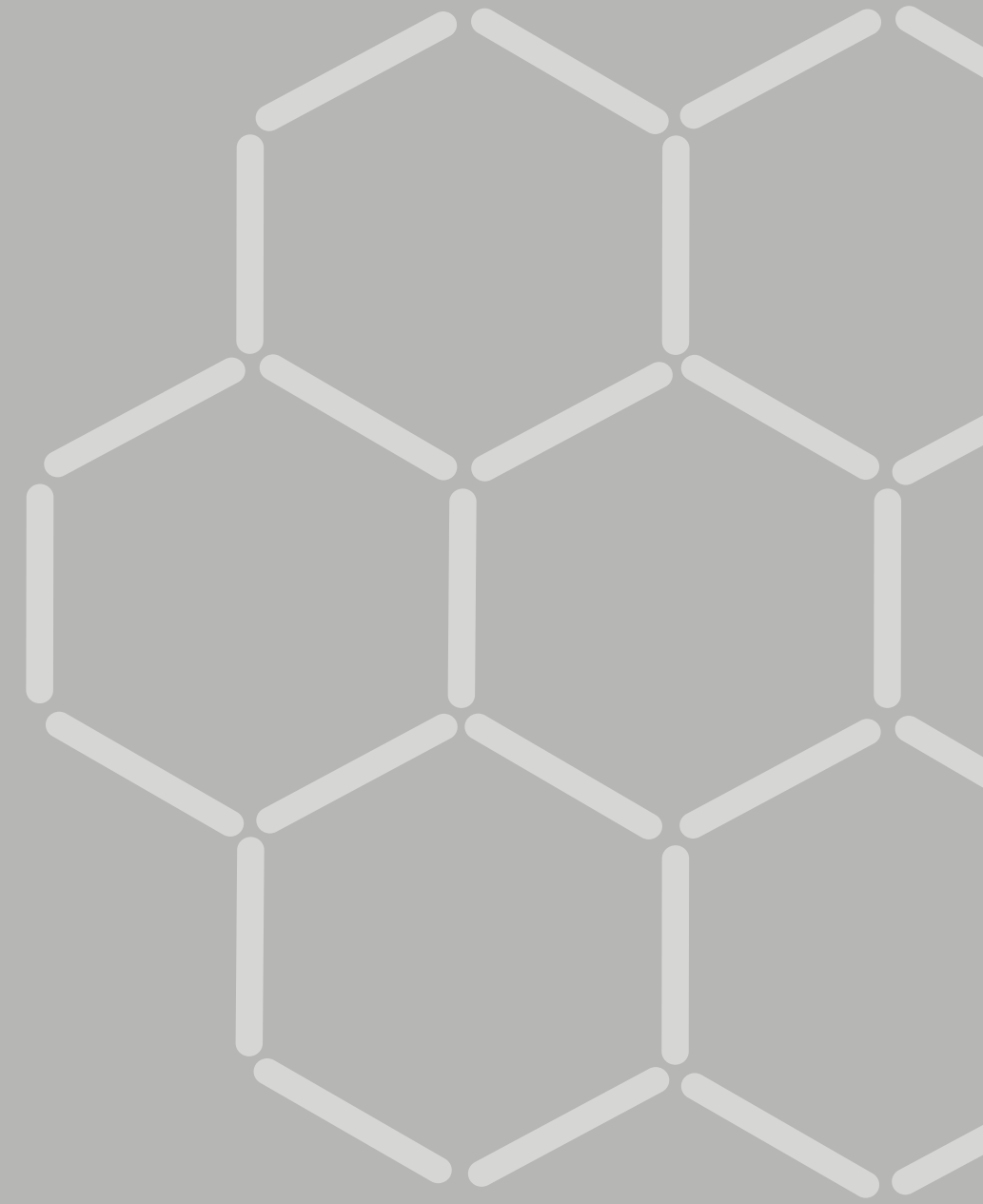



LINK PANELS

END AND GROWTH PANELS

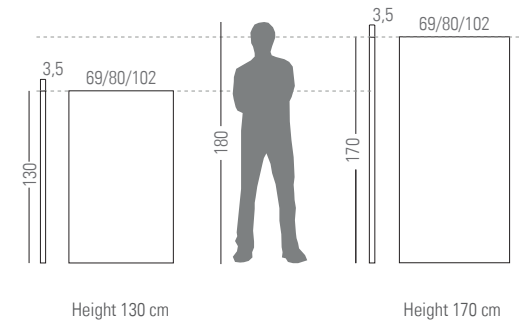

PANELS FOR CHANGE OF HEIGHT

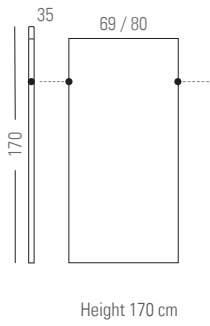

WITHOUT PLACEMENT OF THE TABLE  
 PLACEMENT OF THE TABLE 1 SIDED  
 PLACEMENT OF THE TABLE 2 SIDED  
 PANELS FOR CHANGE OF HEIGHT

PANELS FOR TABLES

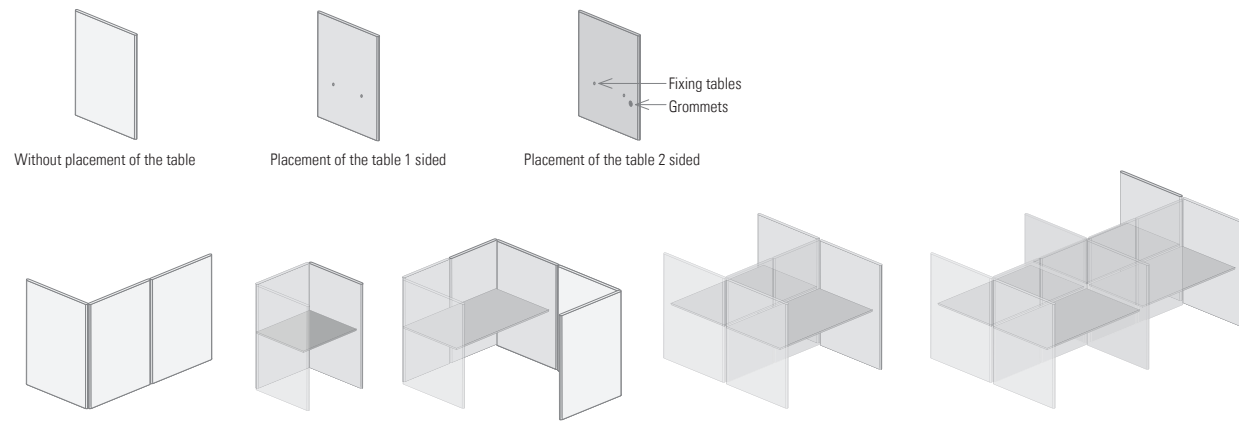

SEAT PANELS

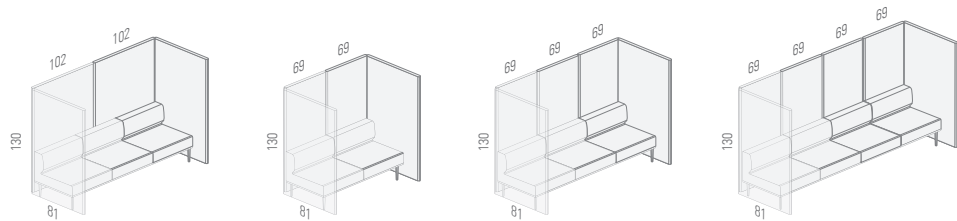

WORK SURFACES

WORK SURFACES FOR THE USE OF LINK WITH A HEIGHT ADJUSTMENT SYSTEM - WIDTH 68 CM

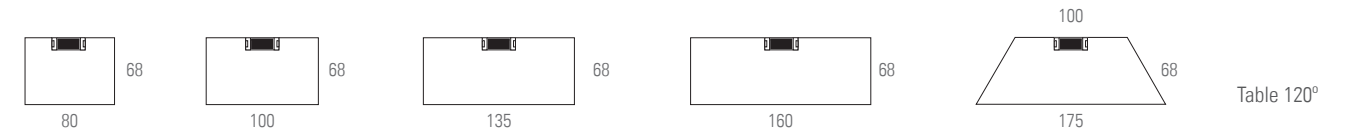

WORK SURFACES FOR THE USE OF LINK WITH A HEIGHT ADJUSTMENT SYSTEM - WIDTH 78 CM

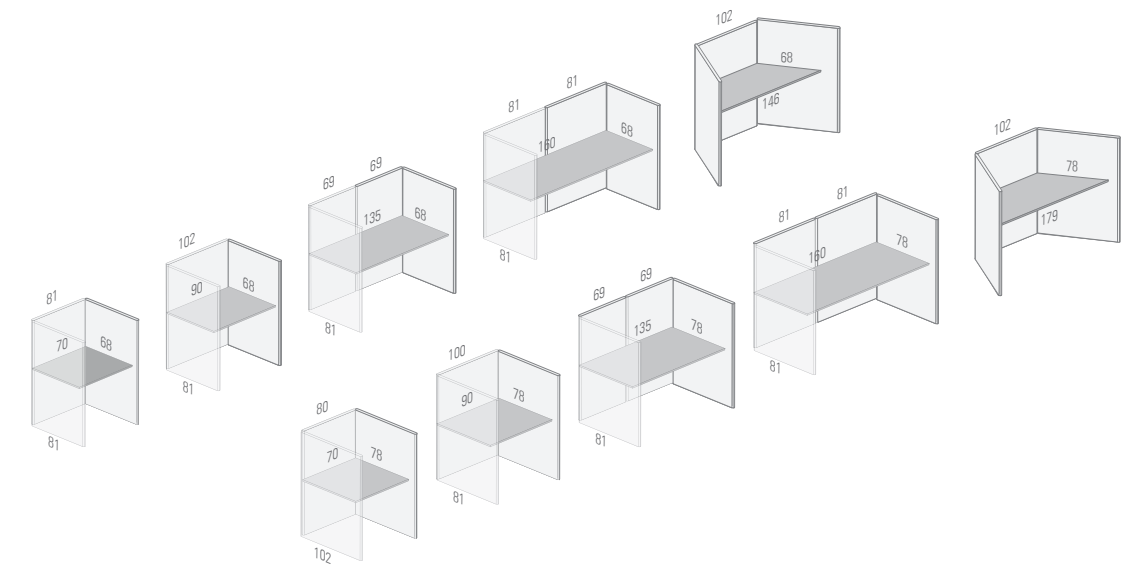
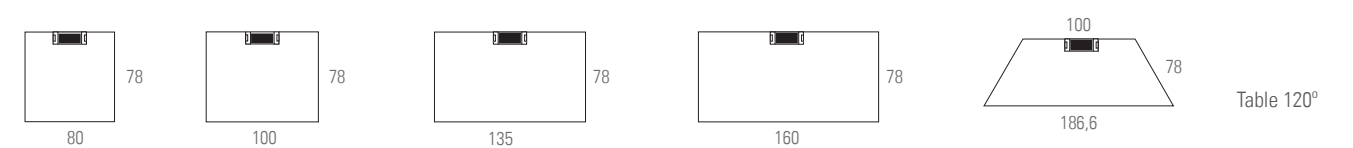

OPTIONAL ACCESSORIES FOR LINK

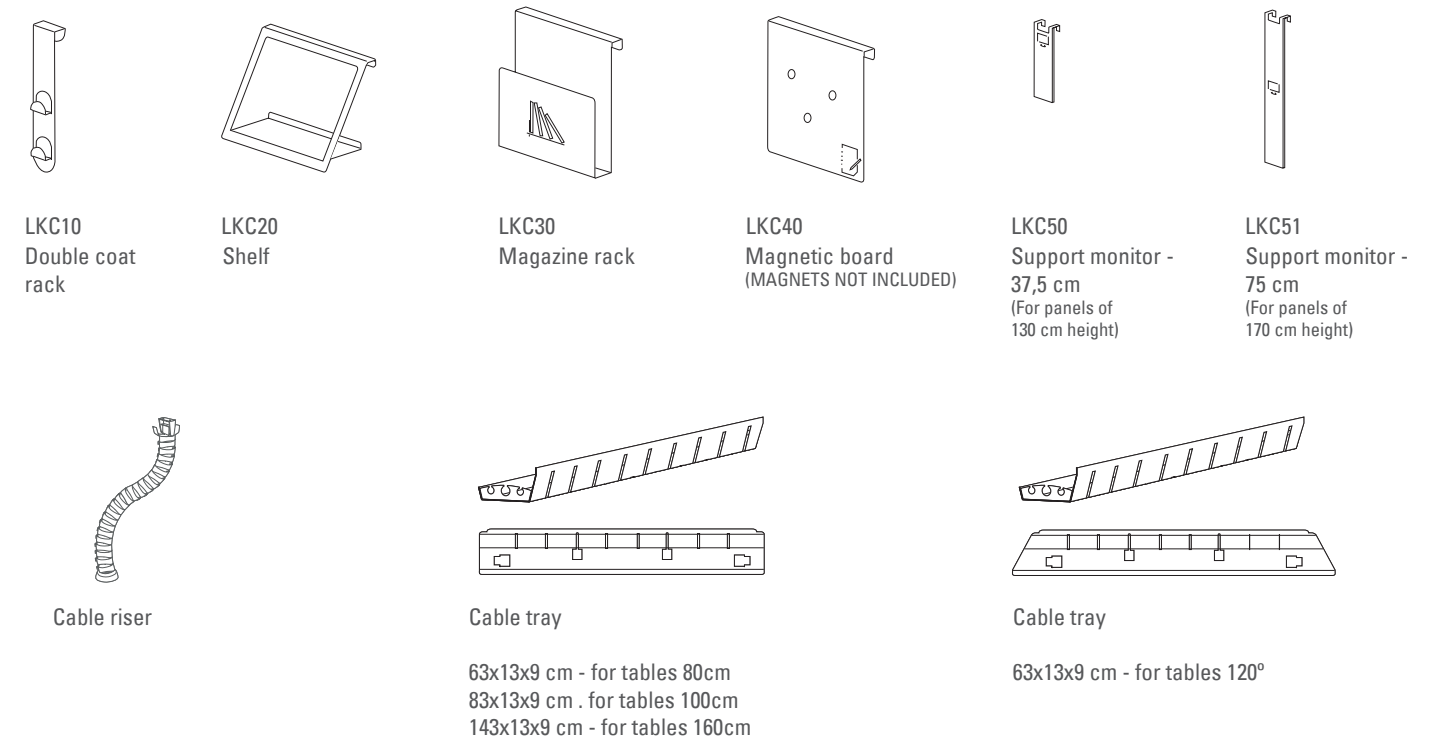



LINK JOINT SYSTEMS

ANCHORAGE SYSTEMS FOR CONFIGURATIONS OF THE SAME HEIGHT

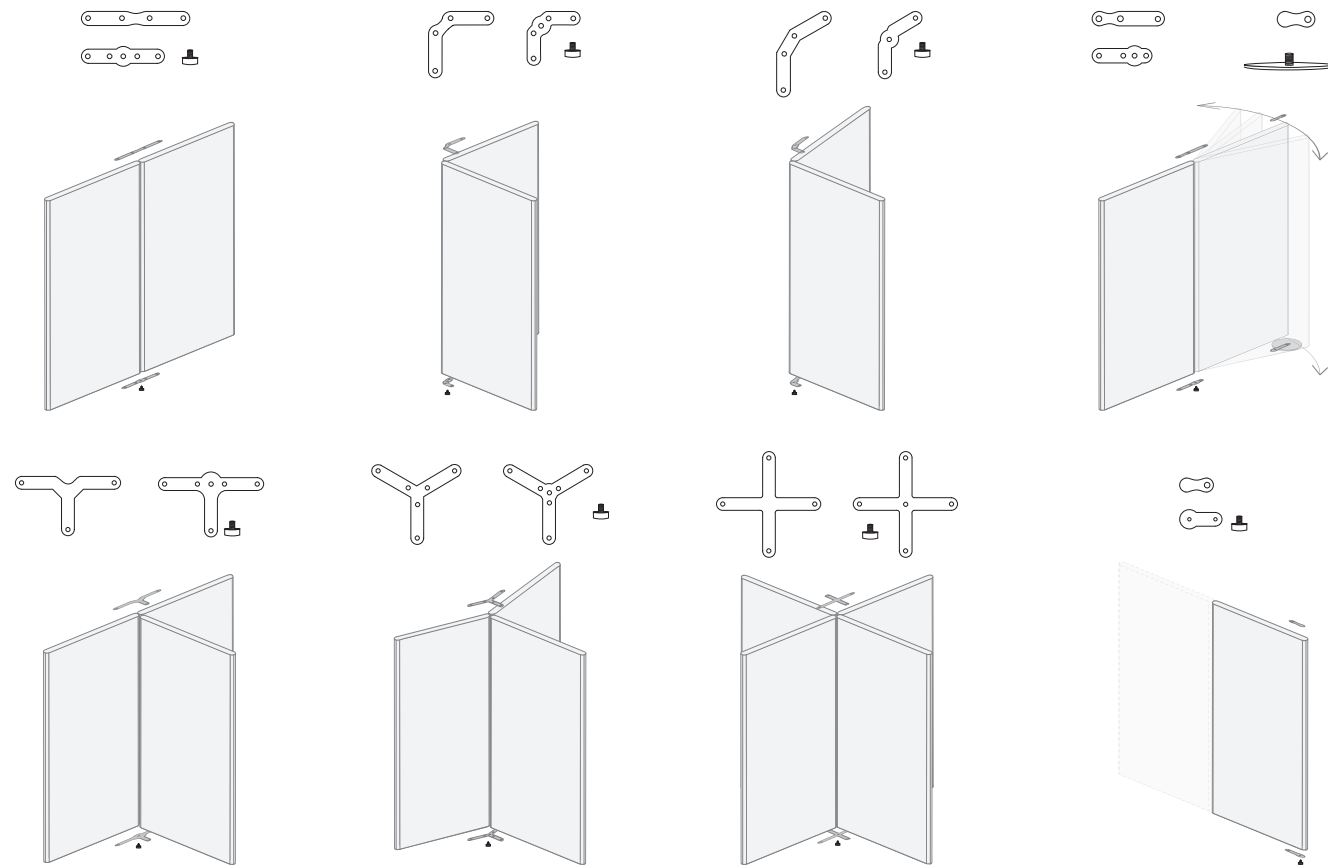

ANCHORAGE SYSTEMS FOR CONFIGURATIONS OF HEIGHT CHANGE

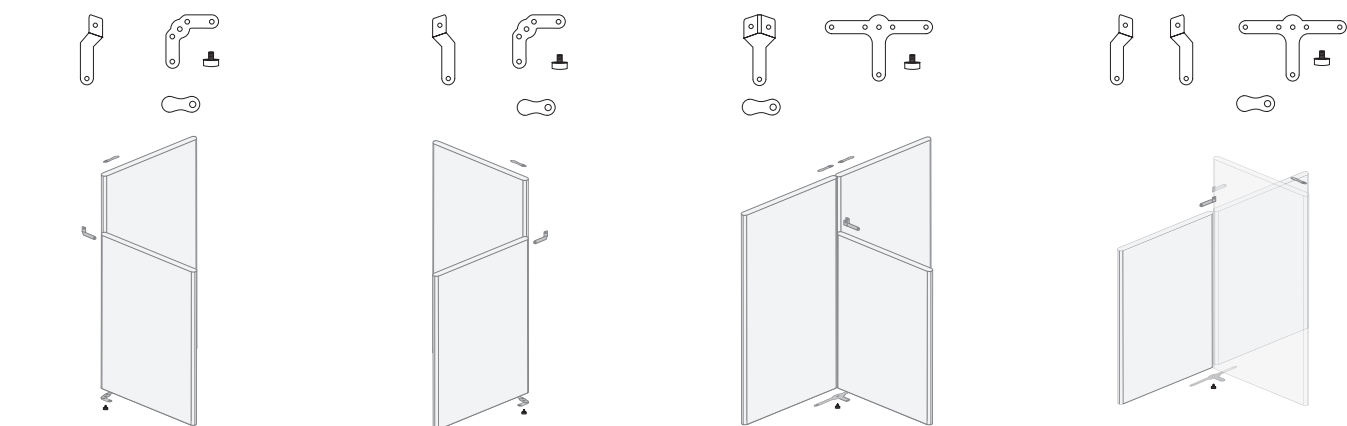

ANCHORAGE SYSTEMS FOR CONFIGURATIONS OF THE PANEL STRIPPERS

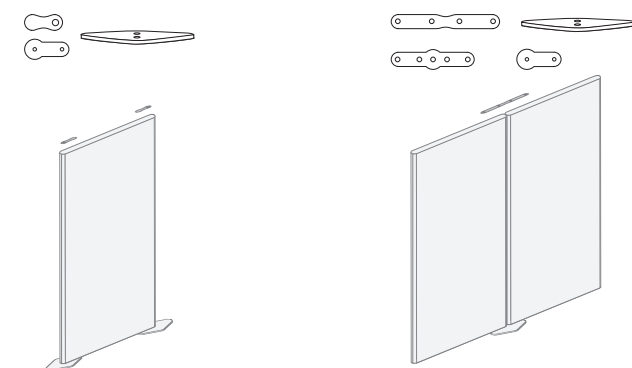

STEPS CREATING COMPOSITIONS

STEP 1  
Ground settings

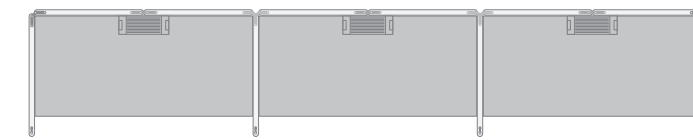

STEP 2  
Identify unions

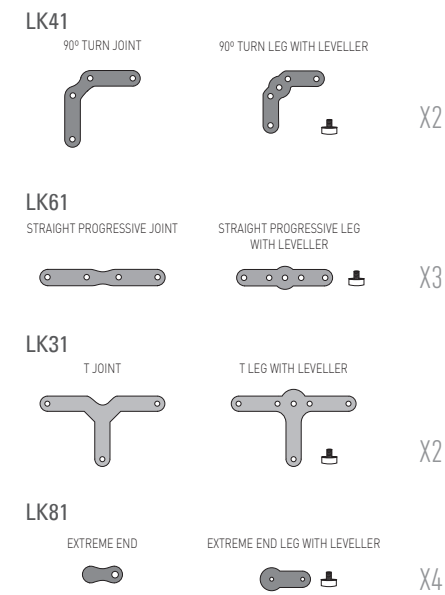

STEP 3  
Identify panels

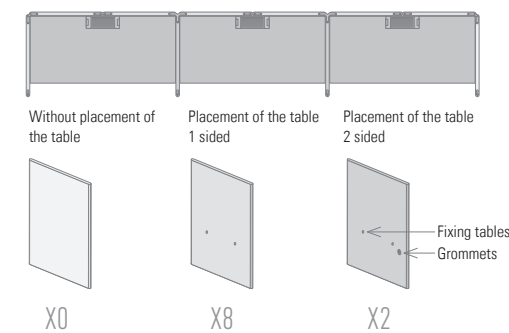

STEP 4  
Define tables and cable trays



STEP 5  
Define finishes of partitions and tables

# MAKE YOUR LINK PROJECTS COME TRUE ACTIU PLANNER

Make your Link projects come true with **Actiu Planner**.  
Fast, Easy, Visual.  
The Actiu software with intelligent product libraries, allows you to visualize and do great quality virtual animations.

Haga realidad sus proyectos Link con **Actiu Planner**.  
Rápido, Fácil, Visual.  
El software de Actiu con librerías de producto inteligentes que le permitirá realizar visualizaciones y animaciones virtuales de gran calidad.



ORTHOGONAL COMPOSITION EXAMPLES

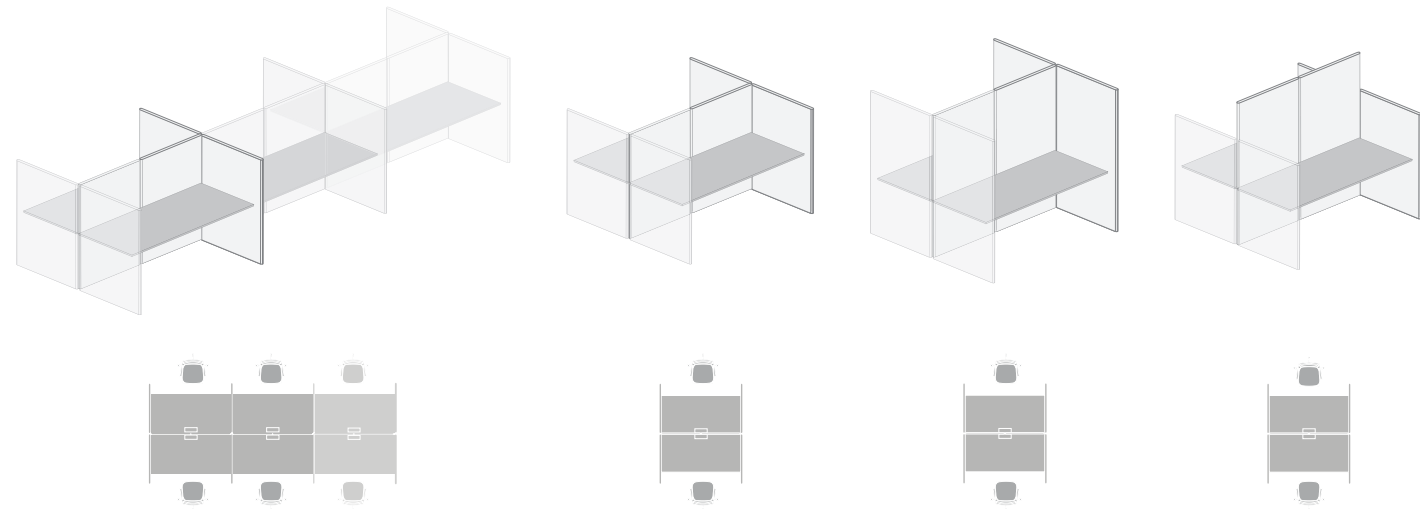
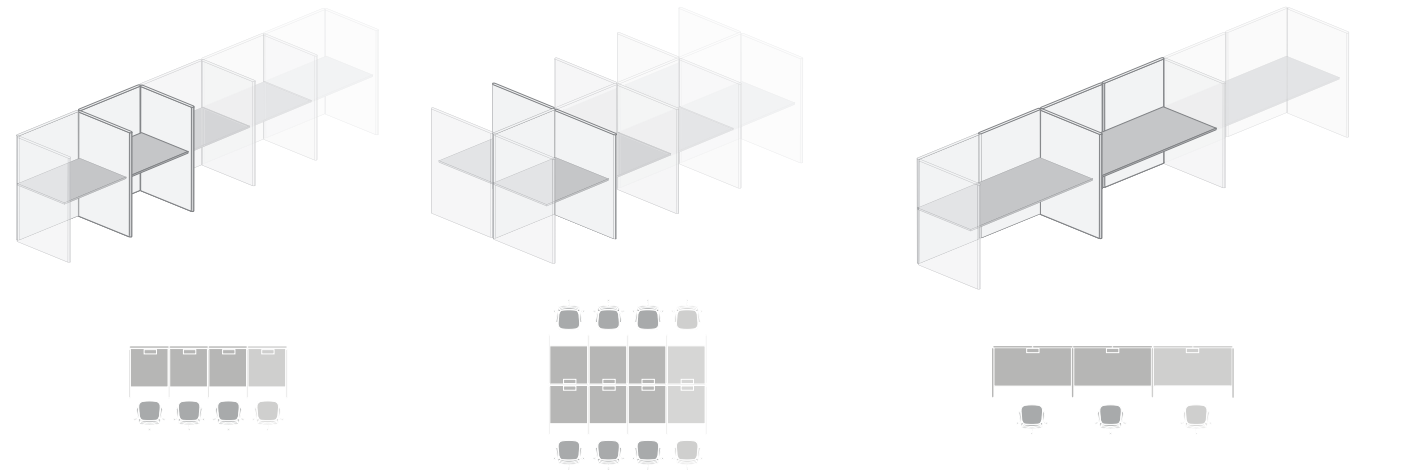

COMPOSITION NOT RECOMMENDED

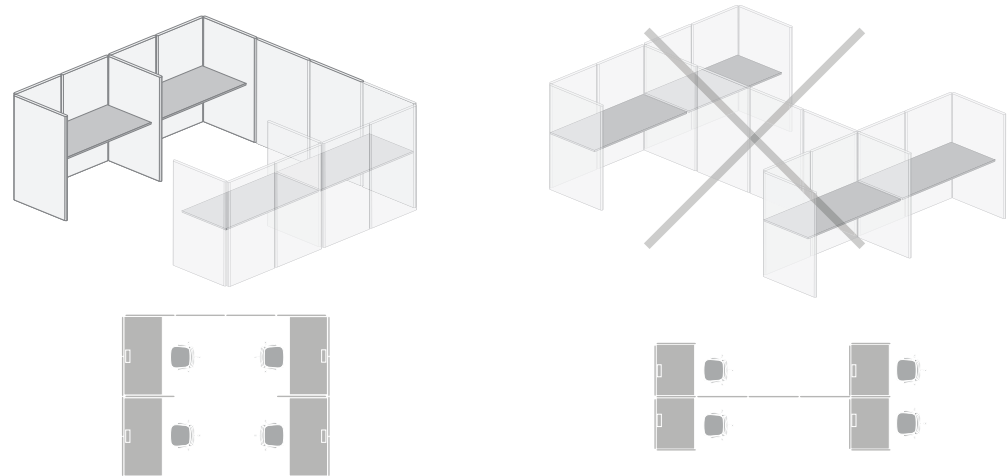

HEXAGONAL COMPOSITION EXAMPLES

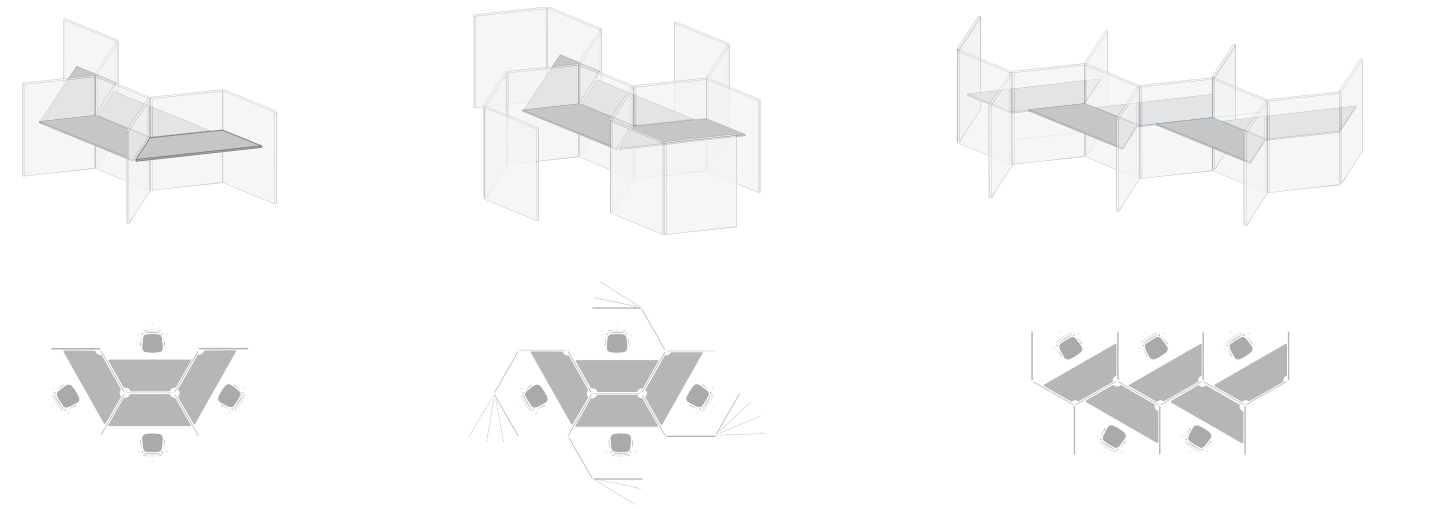
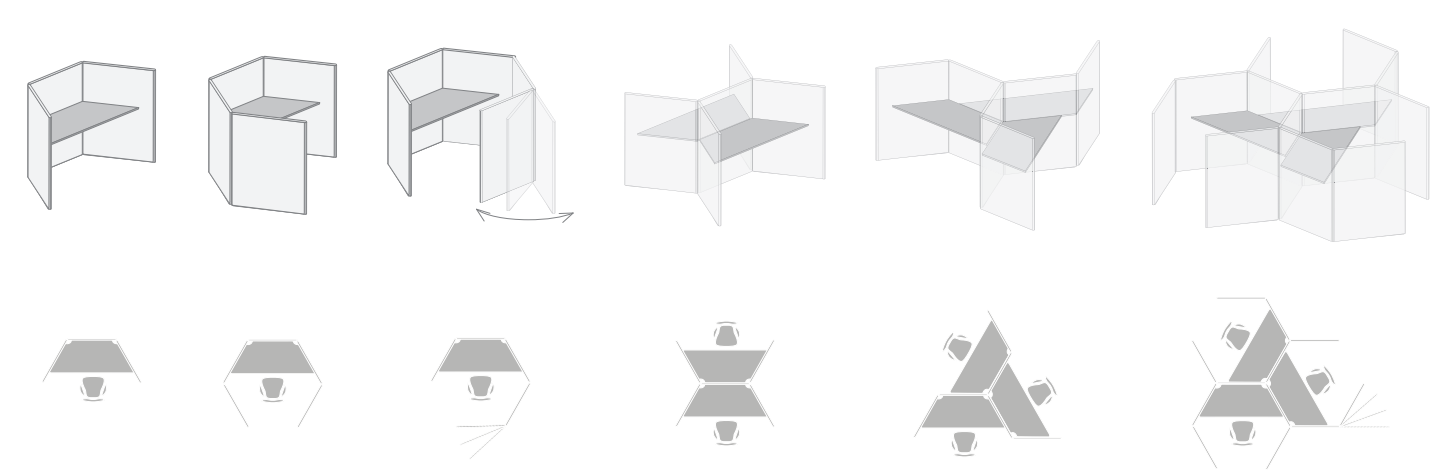

COMPOSITIONS NOT RECOMMENDED

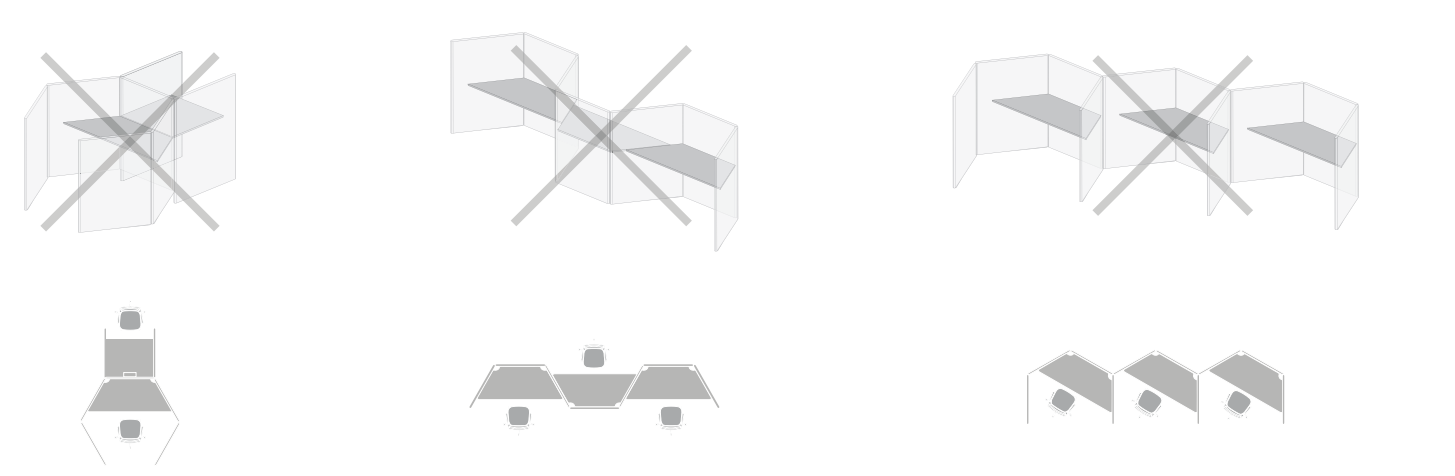



EXAMPLES OF COMPOSITION



FINISHES

TABLES

MELAMINE



WHITE

LIME OAK

CHESTNUT

PANELS

UPHOLSTERY

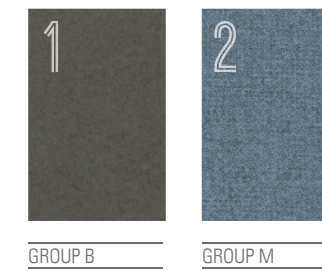

GROUP B

GROUP M

ACCESSORIES

SHEET STEEL



WHITE

BLACK

SUPERIOR AND LOWER JOINING PIECE

ALUMINIUM



BLACK





# ACTIU

## 45 YEARS DESIGNING PUBLIC AND WORK SPACES

Actiu is a company with an industrial career in the installation sector, specializing in the creation of furniture, whose flexibility and productive capacity allow the development of global sourcing projects at an international level offering solutions which provide for the welfare of people.

### ACTIU TECHNOLOGY PARK A sustainable industrial project.

A flexible, open and transparent architecture space. A project with new prospects certified by LEED® Gold for all the existing buildings that point Actiu as a referent in Europe.

- Energetic production solar plant: 7.000.000 kWh per year
- Rainfall water collection (12.000 m³ capacity)
- Water Tanks: 12.000 m³
- Meeting points, club and nursery service
- Green areas: 130.000 m²
- Total Industrial surface: 200.000 m²
- Corporate Headquarter building: 6.000 m²
- Logistics centre: 18.000 m²
- Production plants: 40.000 m²



ACTIU TECHNOLOGY PARK  
project certified as LEED® GOLD  
by U.S. Green Building Council 2011  
Leadership in Energy & Environmental Design



ACTIU TECHNOLOGY PARK

### ACTIU TECHNOLOGY PARK

Architecture linked to the local industry  
A philosophy turned into architecture.

Architect: José María Tomás Llavador

### DESIGN & ARCHITECTURE

Space management and design  
Products. Own patents  
Communication

### SUSTAINABILITY

Sustainable production  
Product. Eco-design  
Services, effective logistics system  
Actiu Technology Park, certified LEED® Gold

### MANUFACTURER

We are manufacturers  
Domain raw materials and processes  
Technology and Innovation  
Standardized and specific solutions

### GLOBAL COVERAGE

Presence in more than 65 countries  
Global equipment solutions. Corporate, Health,  
Education, Contract, Transport,...







## LIFE CYCLE ANALYSIS

### ENVIRONMENTAL PRODUCT DECLARATION



**MATERIALS:**  
Including the extraction and processing of raw materials and component sourcing to its delivery at the Actiu Technology Park.



**PRODUCTION:**  
Consider the production and assembly processes used in Actiu.



**TRANSPORT:**  
Includes transportation from the Actiu Technology Park to the our customers facilities ( light commercial transport).

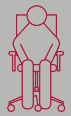

**USE:**  
This stage has not environmentally relevance for life cycle analysis.



**DISPOSAL:**  
Any product can be disposed of in different ways, or become a resource. Aluminum, wood and cardboard packaging is recycled, while the rest is treated as urban waste.

## CERTIFICATES AND REFERENCES

ACTIU products fulfill all demands about management, quality and sustainability to provide extra value to the projects using recycled materials to get the recyclable final product.



Actiu has made this document with 100% recycled paper reducing environmental impact as follows:

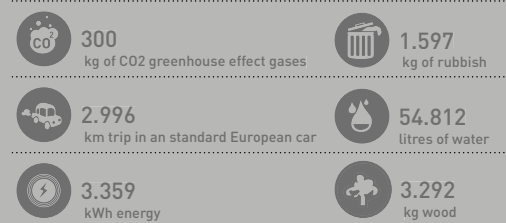





[www.actiu.com](http://www.actiu.com)